

Ansicht 1 / 3D

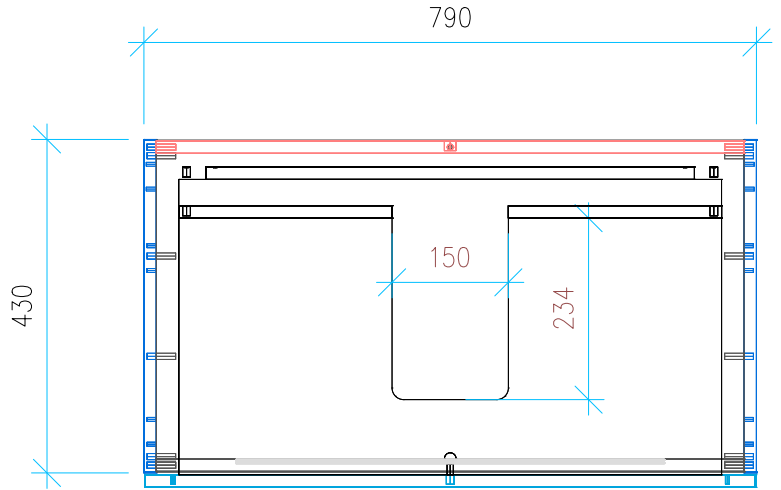

Ansicht 2 / Draufsicht

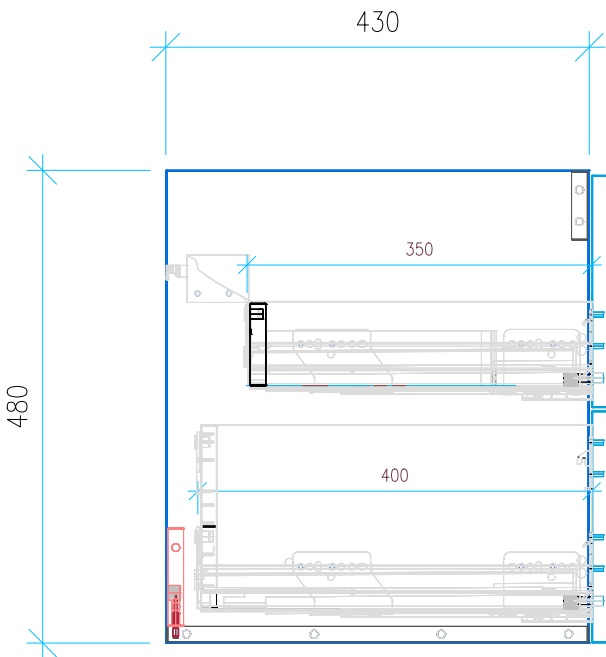

Ansicht 3 / Seitenansicht Links

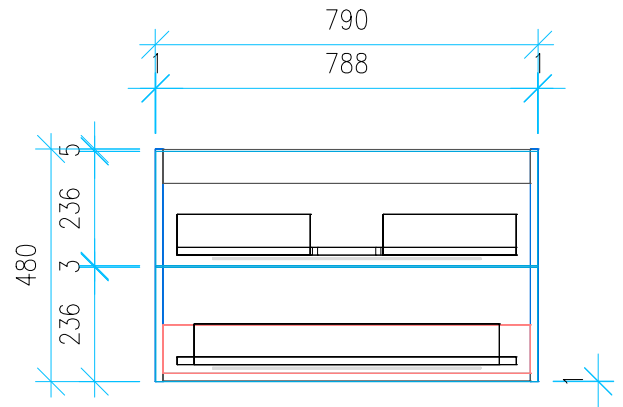

Ansicht 4 / Vorderansicht

Höhe <b>480</b> Breite <b>790</b> Tiefe <b>430</b>	Erstellt <b>11.07.2024</b>	Artikelname
	Maße in mm	WTU_SCA_TEOR2_0_80_SLV_PTO
	Gewicht in kg	