

Ansicht 1 / 3D

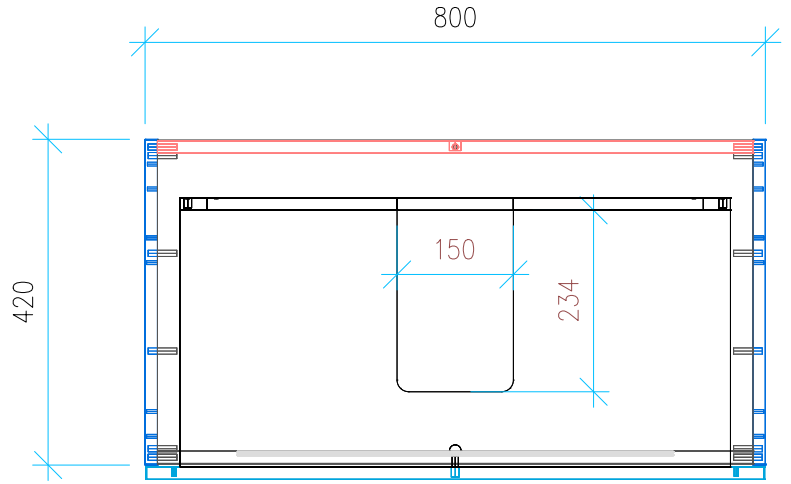

Ansicht 2 / Draufsicht

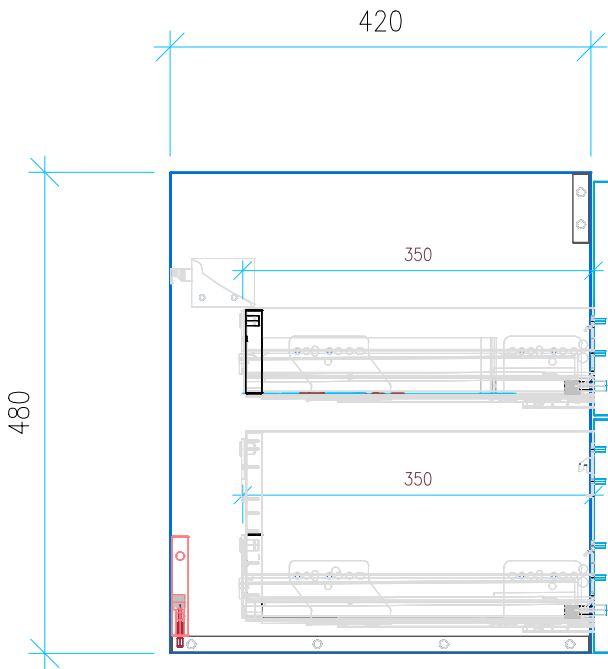

Ansicht 3 / Seitenansicht Links

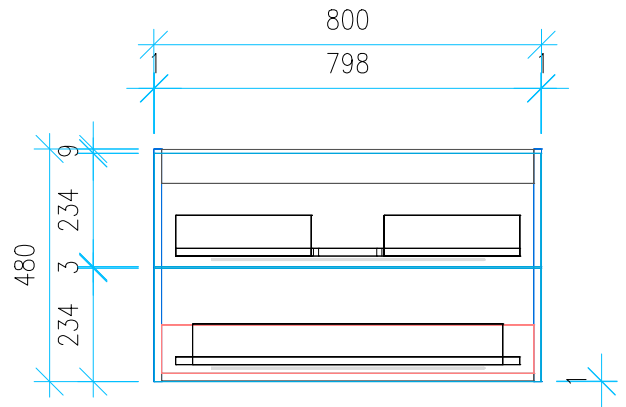

Ansicht 4 / Vorderansicht

Höhe <b>480</b>	Erstellt <b>18.07.2022</b>	Artikelname
Breite <b>800</b>	Maße in mm	<b>WTU_LAUF_PROS_85_SC_PTO</b>
Tiefe <b>420</b>	Gewicht in kg	
Gewicht <b>22.392</b>		