

Ansicht 1 / 3D

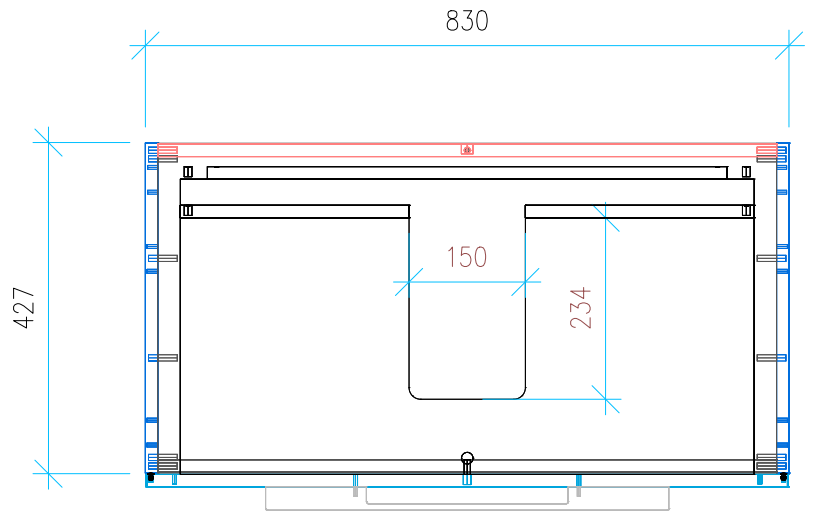

Ansicht 2 / Draufsicht

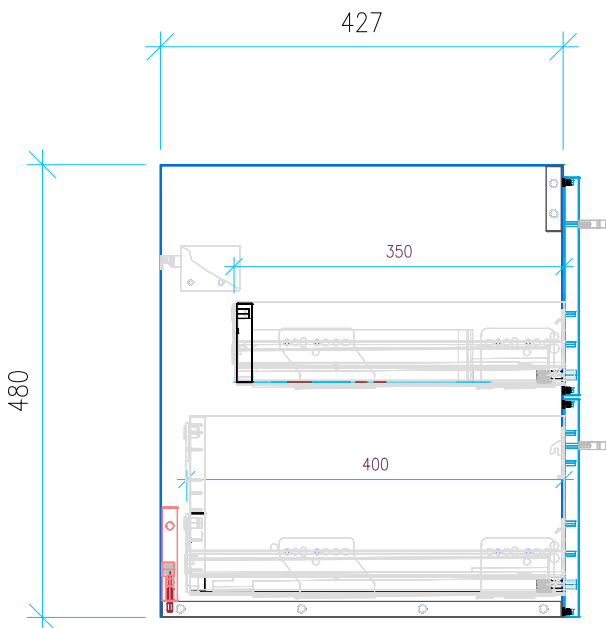

Ansicht 3 / Seitenansicht Links

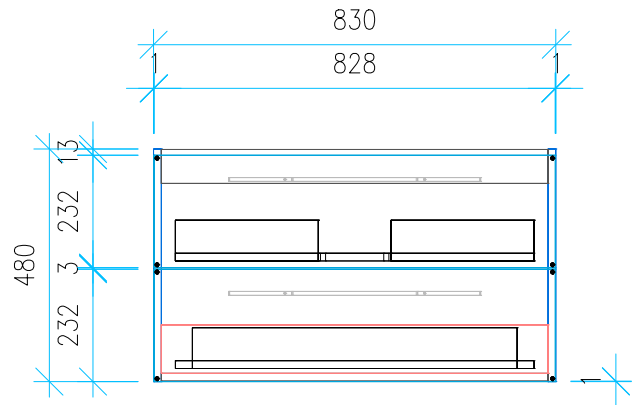

Ansicht 4 / Vorderansicht

Höhe 480	Erstellt 11.07.2022	Artikelname
Breite 830	Maße in mm	WTU_GEB_REN_PLAN_90_SC
Tiefe 427	Gewicht in kg	
Gewicht 24.04		