

Ansicht 1 / 3D

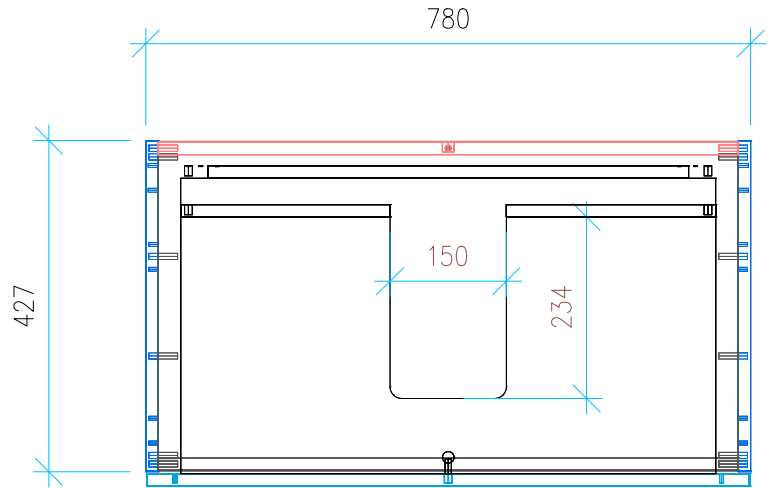

Ansicht 2 / Draufsicht

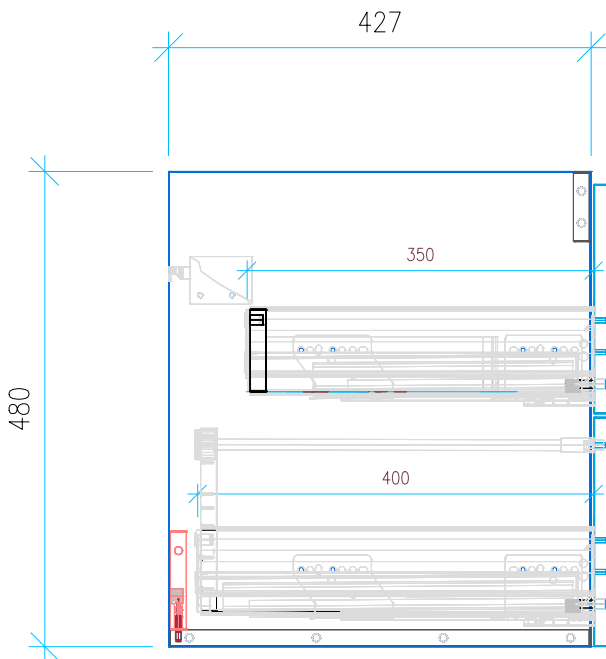

Ansicht 3 / Seitenansicht Links

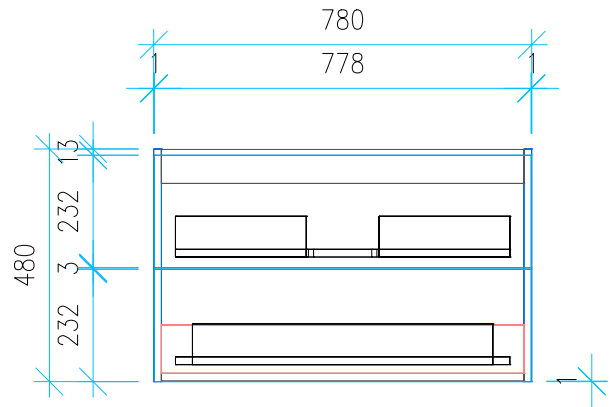

Ansicht 4 / Vorderansicht

Höhe 480 Breite 780 Tiefe 427	Erstellt 29.11.2022	Artikelname WTU_GEB_REN_PLAN_85_NP_PTO
	Maße in mm	
	Gewicht in kg	