

Ansicht 1 / 3D

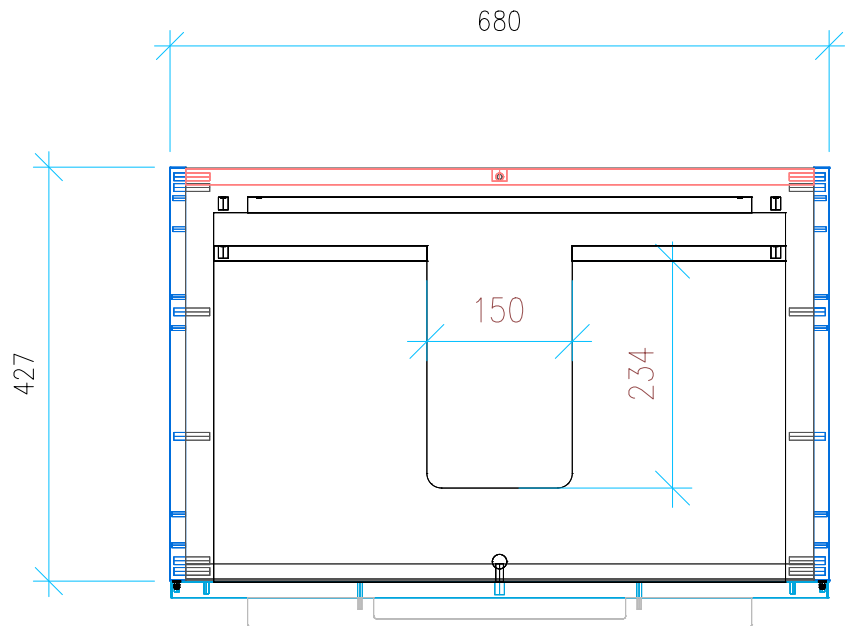

Ansicht 2 / Draufsicht

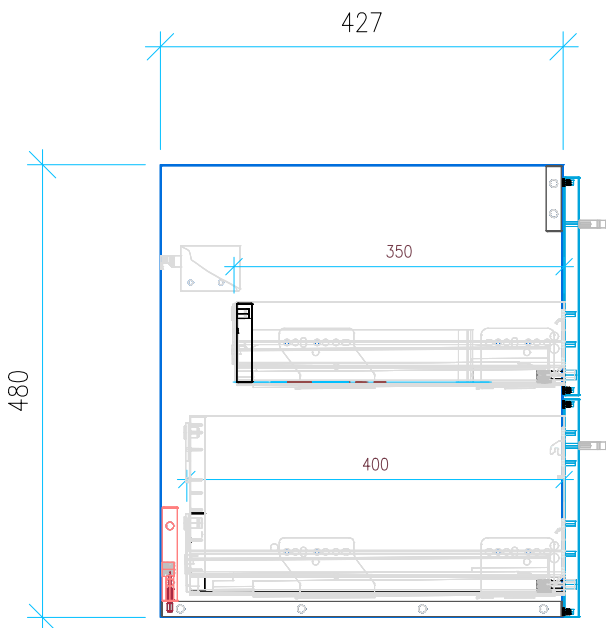

Ansicht 3 / Seitenansicht Links

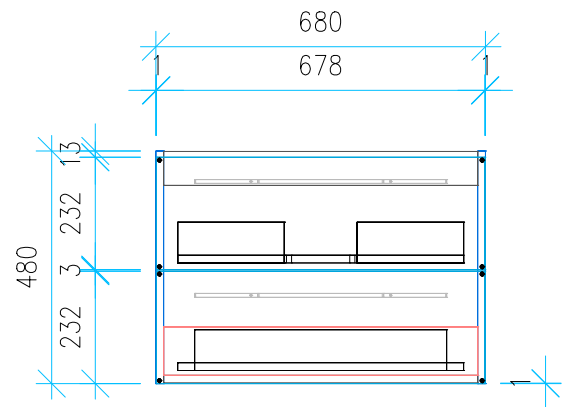

Ansicht 4 / Vorderansicht

Höhe <b>480</b>	Erstellt <b>11.07.2022</b>	Artikelname
Breite <b>680</b>	Maße in mm	WTU_GEB_REN_PLAN_75_SC
Tiefe <b>427</b>	Gewicht in kg	
Gewicht <b>20.546</b>		