

Ansicht 1 / 3D

Ansicht 2 / Draufsicht

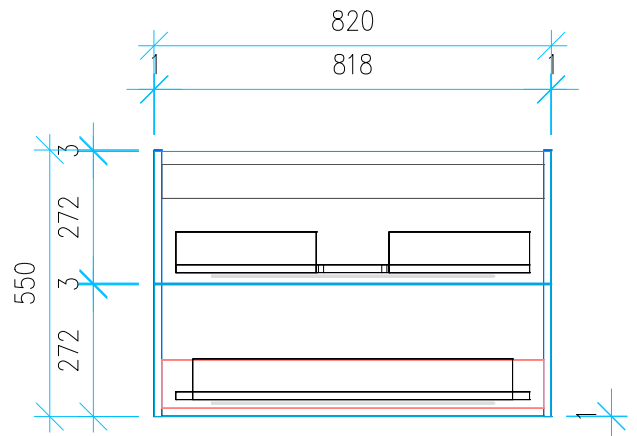
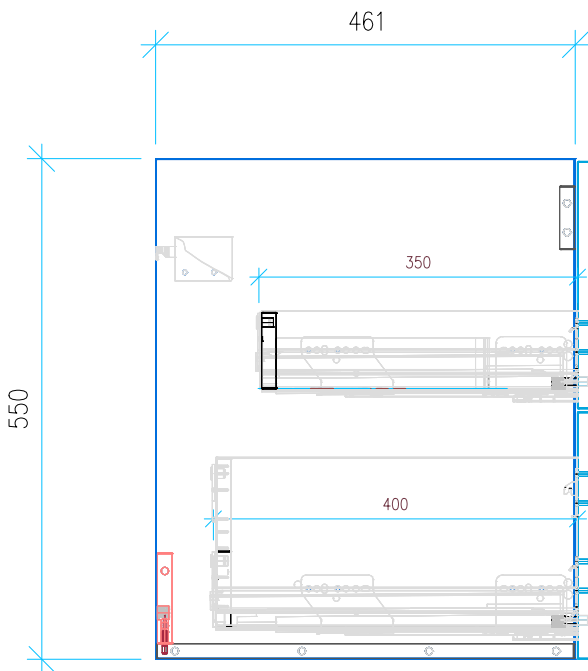

Ansicht 3 / Seitenansicht Links

Ansicht 4 / Vorderansicht

Höhe <b>550</b>	Erstellt <b>01.07.2022</b>	Artikelname
Breite <b>820</b>	Maße in mm	<b>WTU_DUR_P3_COMFOR_85_SC_PTO</b>
Tiefe <b>461</b>	Gewicht in kg	
Gewicht <b>26.04</b>		